

— = systeemkabel
Bij andere getwiste kabel **66%** afstand!
Bij ongetwiste kabel **max. 50 meter** buitenpost naar videofoon.
UTP op aanvraag.

Digitizers & flatcables



Niet monteren/demonteren onder spanning

DD8 digitizer: flatcable



Connector van flatcable **nokje juiste kant op** bij aansluiten op DD8

TWEEDRAADS BUS



Bij monteren/demonteren **spanning eraf** voorkomt defecten!

VideoVerdeler



De aders moeten **echt OP de klemmen** doorgelust worden!

BT-Rel 346210

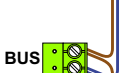

De aders moeten **echt OP de connector** doorgelust worden!

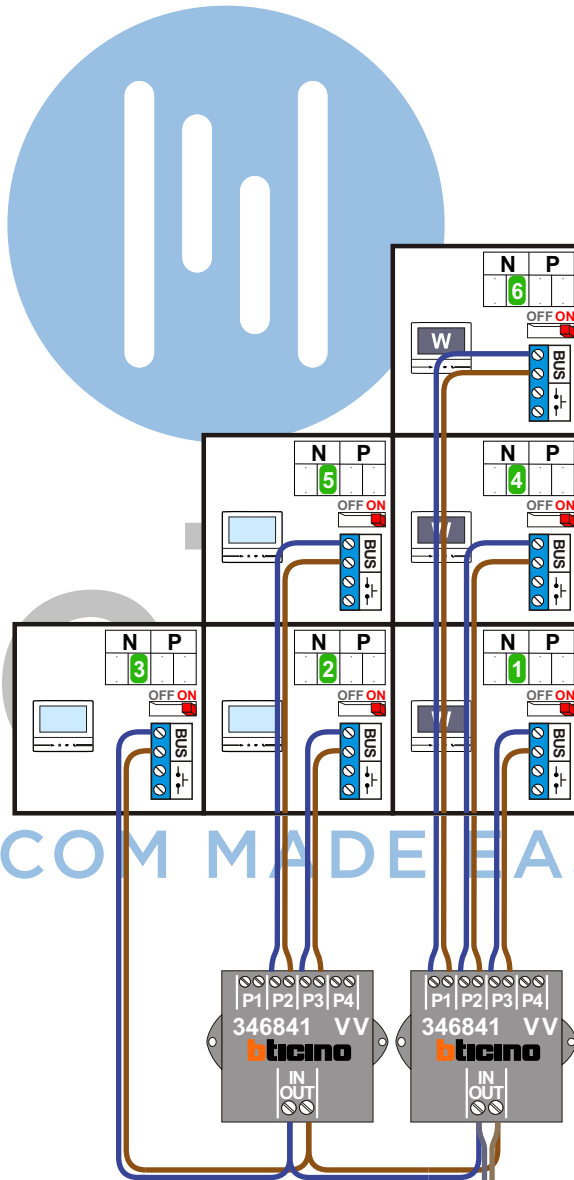
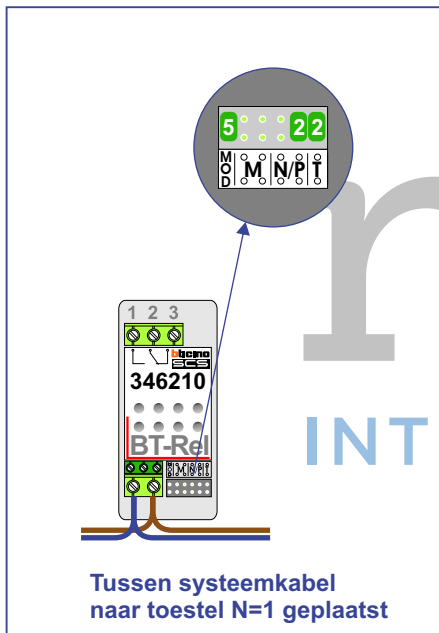

INTERCOM MADE EASY

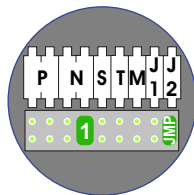

Pot.vrij contact tbv deuropener

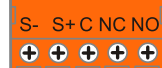

Haal de spanning van het systeem als je de digitizer monteert of demonteert

DEURSTATION S-130V

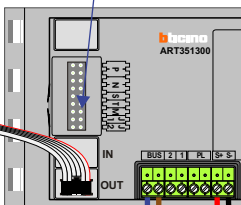

Digitizer voor 1 t/m 8 drukkers

nokjes connectoren wijzen naar elkaar

Max. 50 meter

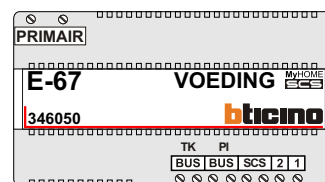

Max. 100 meter systeemkabel tot laatste videofoon



| N-waarde | Huisnummer | Eindweerstand | Toestel |
|----------|------------|---------------|---------|
| 1 | 116 | X | M-70W |
| 2 | 118 | X | M-70 |
| 3 | 120 | X | M-70 |
| 4 | 122 | X | M-70W |
| 5 | 124 | X | M-70 |
| 6 | 126 | X | M-70W |

INTERCOM MADE EASY