 = systeemkabel  
Bij andere getwiste kabel **66%** afstand!  
Bij ongetwiste kabel **max. 50 meter** buitenpost naar videofoon.  
UTP op aanvraag.

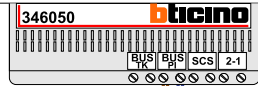

De twee stijgers **echt OP de klemmen** van E-67 aansluiten!

**BUS 2-DRAADS**





Bij monteren/demonteren **spanning eraf** en voorkom defecten!

M-50  
T-55

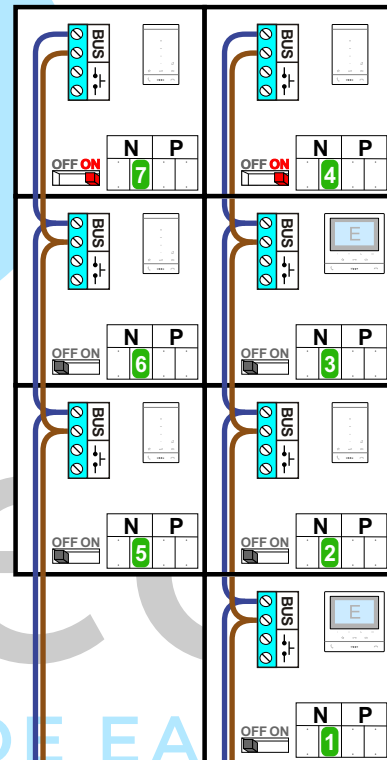

De anders moeten **echt OP de connector** doorgelust worden!

| N-waarde | Huisnummer | Eindweerstand |       |
|----------|------------|---------------|-------|
| 1        | 60         |               | M-50E |
| 2        | 62         |               | T-55  |
| 3        | 64         |               | M-50E |
| 4        | 66         | X             | T-55  |
| 5        | 68         |               | T-55  |
| 6        | 70         |               | T-55  |
| 7        | 72         | X             | T-55  |



nelec  
INTERCOM MADE EASY

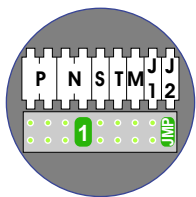

Pot.vrij contact  
tbv deuropener

S- S+C NC NO

Haal de spanning van het systeem als je de digitizer monteert of demonteert

BUITENPOST S-130V

Digitizer voor 1 t/m 8 drukkers

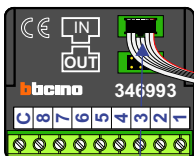

nokjes connectoren wijzen naar elkaar

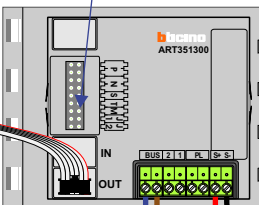

Max. 50 meter

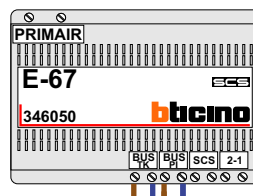

Max. 100 meter systeemkabel tot laatste videofoon

 = systeemkabel  
Bij andere getwiste kabel **66%** afstand!  
Bij ongetwiste kabel **max. 50 meter** buitenpost naar videofoon.  
UTP op aanvraag.

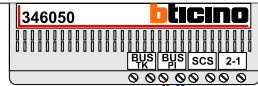

De twee stijgers **echt OP de klemmen** van E-67 aansluiten!

**BUS 2-DRAADS**



Bij monteren/demonteren **spanning eraf** en voorkom defecten!

M-50  
T-55



De anders moeten **echt OP de connector** doorgelust worden!

| N-waarde | Huisnummer | Eindweerstand |       |
|----------|------------|---------------|-------|
| 1        | 60         |               | T-55  |
| 2        | 62         |               | T-55  |
| 3        | 64         |               | M-50E |
| 4        | 66         | X             | M-50E |
| 5        | 68         |               | M-50E |
| 6        | 70         |               | M-50E |
| 7        | 72         | X             | M-50E |

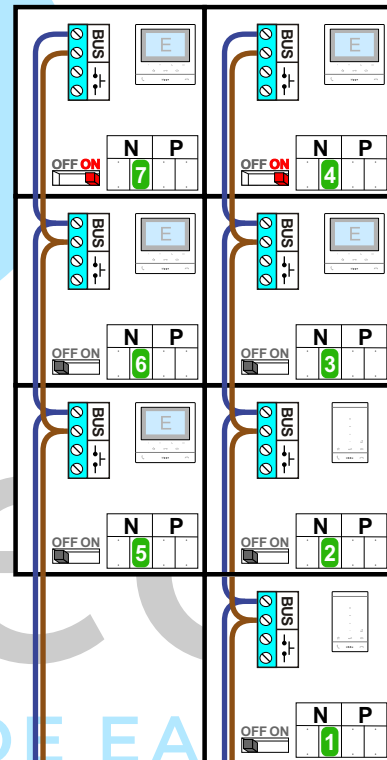

nelec  
INTERCOM MADE EASY

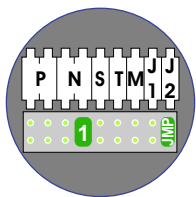

Pot.vrij contact  
tbv deuropener

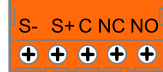

Haal de spanning van het systeem als je de digitizer monteert of demonteert

BUITENPOST S-130V

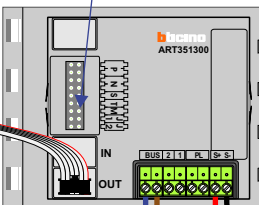

Digitizer voor 1 t/m 8 drukkers

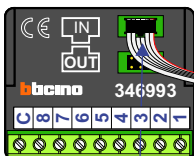

nokjes connectoren wijzen naar elkaar

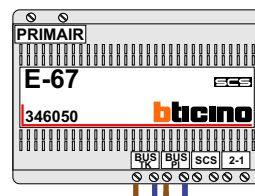

Max. 50 meter

Max. 100 meter systeemkabel tot laatste videofoon