

— = systeemkabel
 Bij andere getwiste kabel **66%** afstand!
 Bij ongetwiste kabel **max. 50 meter** buitenpost naar videofoon.
 UTP op aanvraag.

TWEEDRAADS BUS



Bij monteren/demonteren **spanning eraf** voorkomt defecten!

VideoVerdeler



De aders moeten **echt OP de klemmen** doorgeplust worden!

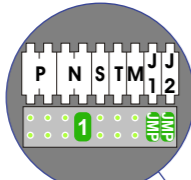
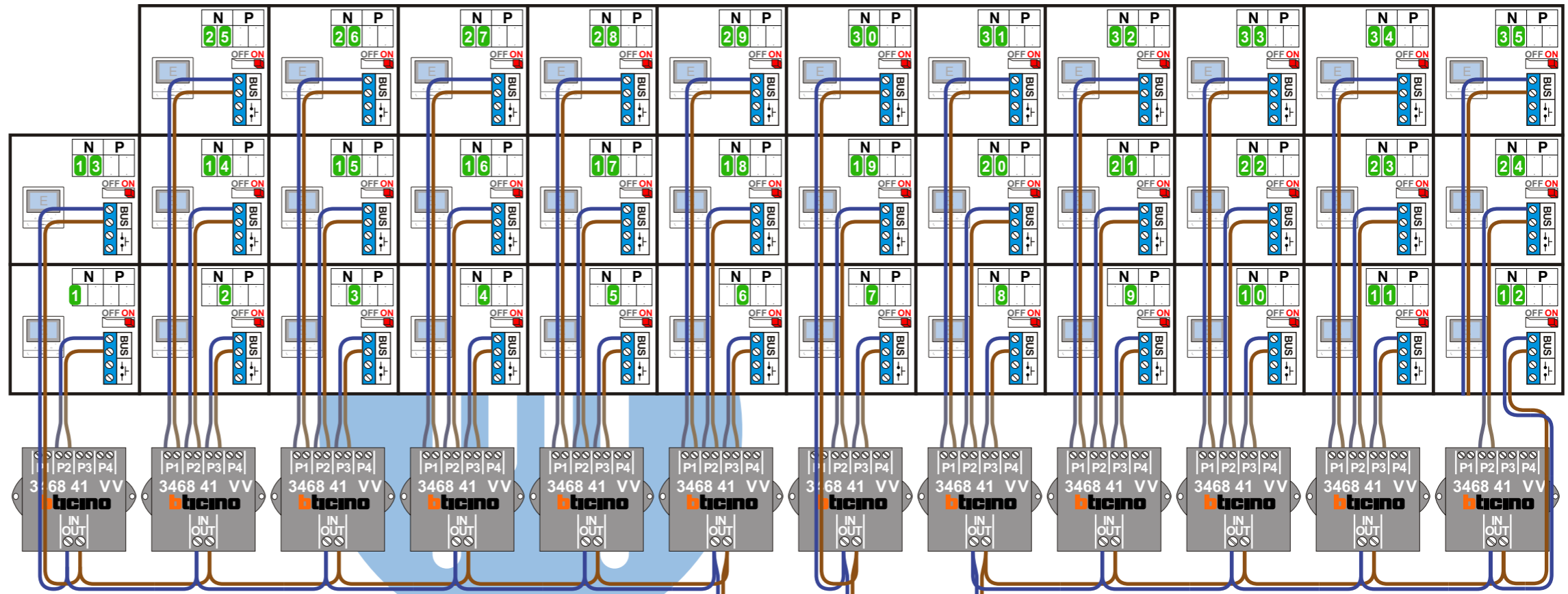

BUITENPOST S-131V

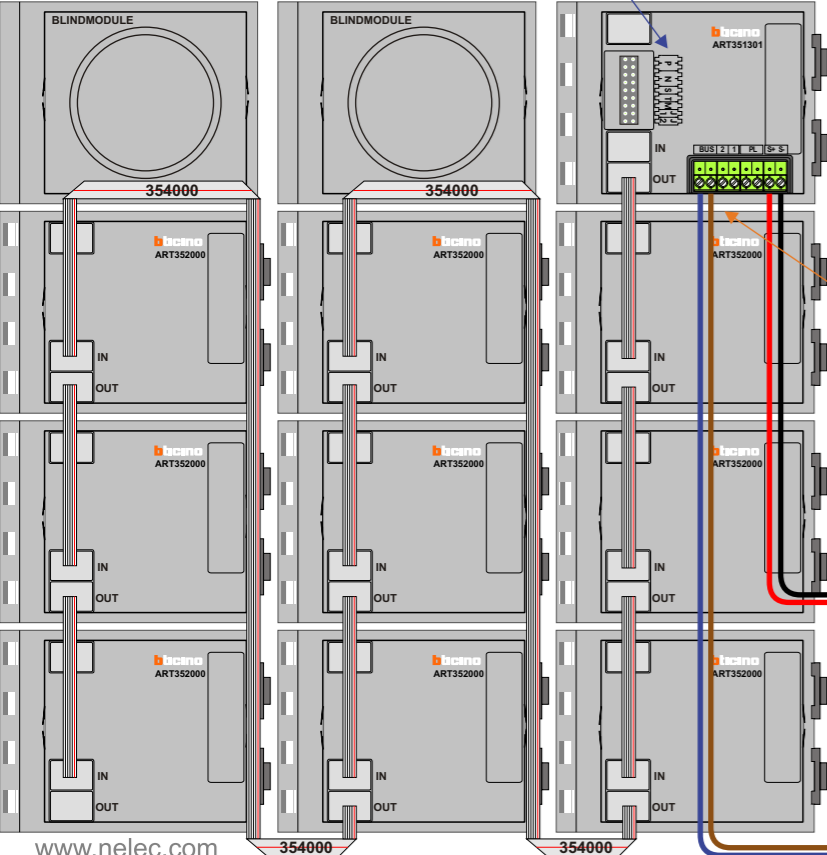

Haal de spanning van het systeem als je een module monteert of demonteert

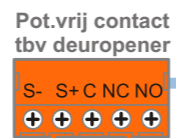

Max. 50 meter

Max. 100 meter systeemkabel tot laatste videofoon

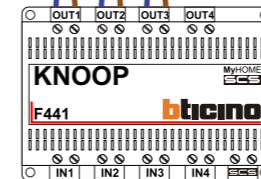

Max. 2 meter

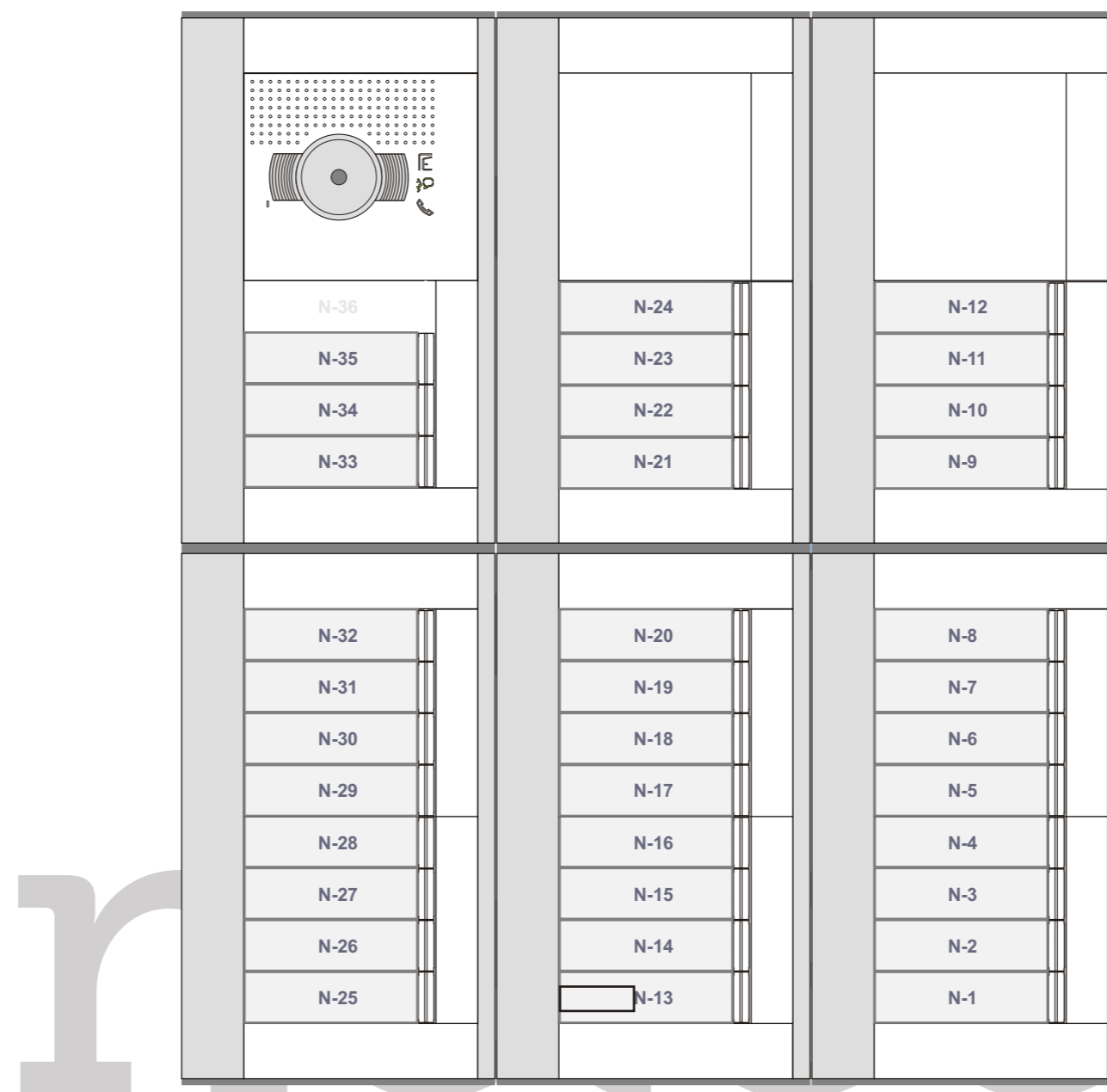

INTERCOM MADE EASY

N-waarde	Huisnummer	Eindweerstand
1	31	X
2	32	X
3	33	X
4	34	X
5	35	X
6	36	X
7	37	X
8	38	X
9	39	X
10	40	X
11	41	X
12	42	X
13	55	X
14	56	X
15	57	X
16	58	X
17	59	X
18	60	X
19	61	X
20	62	X
21	63	X
22	64	X
23	65	X
24	66	X
25	79	X
26	80	X
27	81	X
28	82	X
29	83	X
30	84	X
31	85	X
32	86	X
33	87	X
34	88	X
35	89	X

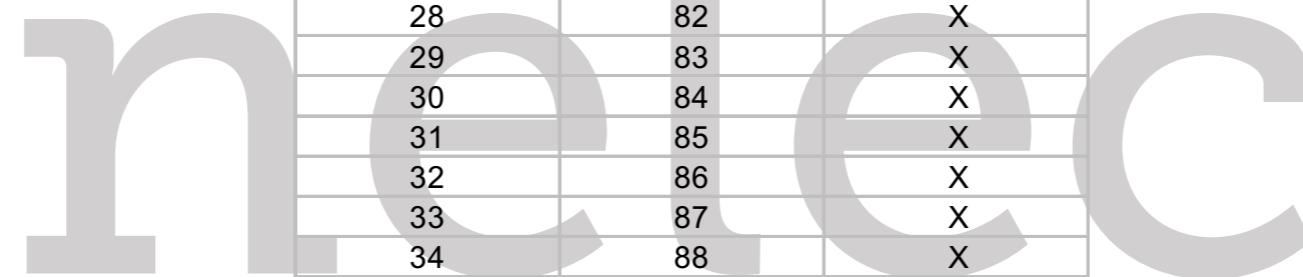
 INTERCOM MADE EASY