

— = systeemkabel
Bij andere getwiste kabel **66%** afstand!
Bij ongetwiste kabel **max. 50 meter** buitenpost naar videofoon.
UTP op aanvraag.

TWEEDRAADS BUS



Bij monteren/demonteren **spanning eraf** voorkomt defecten!

VideoVerdeler



De aders moeten **echt OP de klemmen** doorgeplust worden!

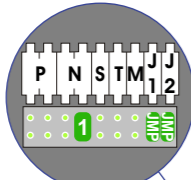
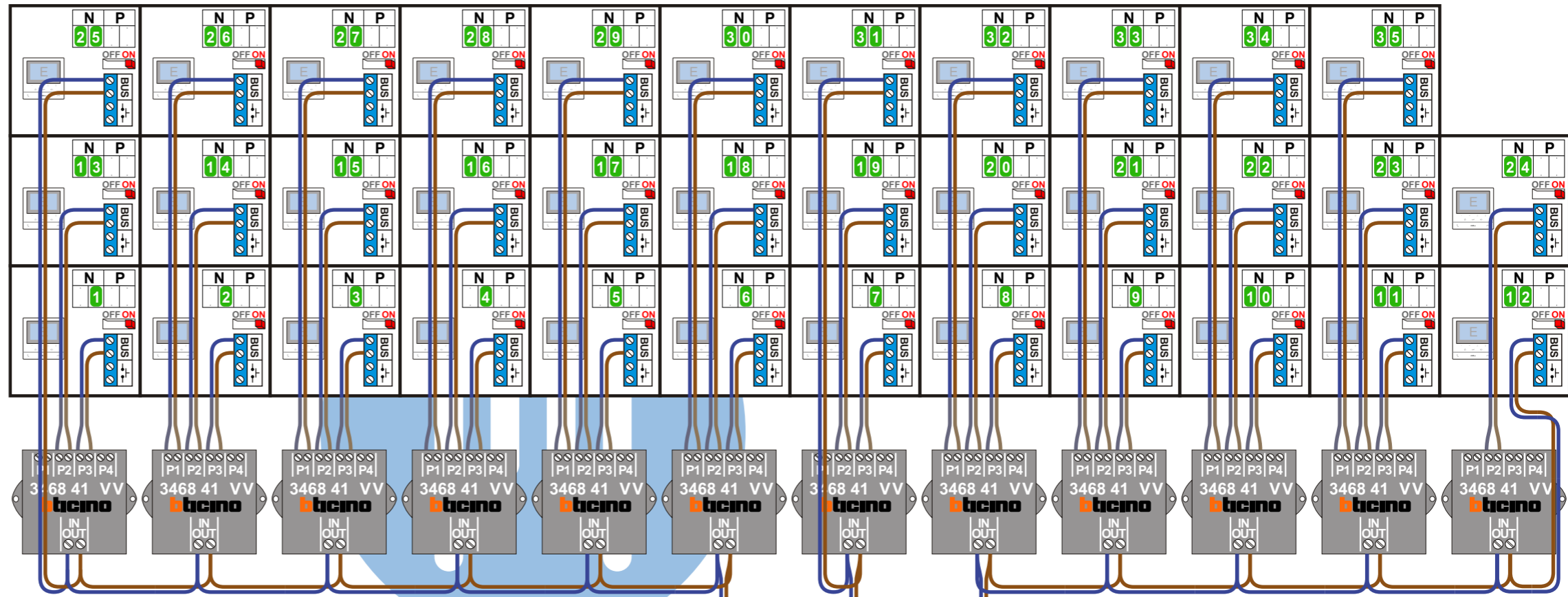

BUITENPOST S-131V

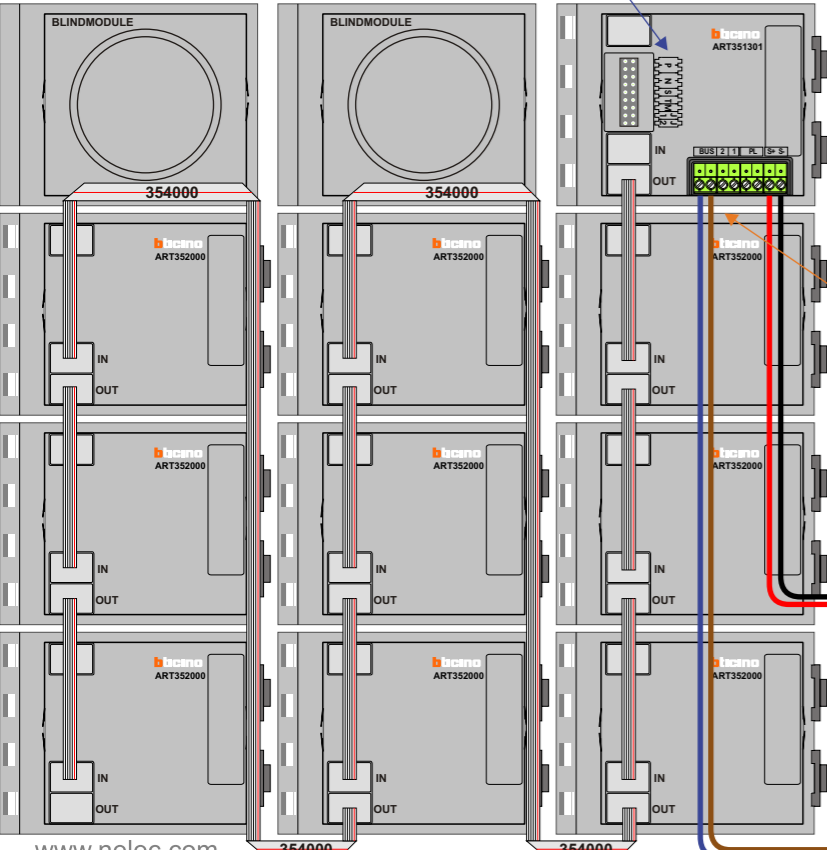

Haal de spanning van het systeem als je een module monteert of demonteert

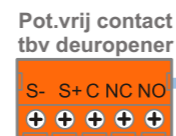

Max. 50 meter

Max. 100 meter systeemkabel tot laatste videofoon

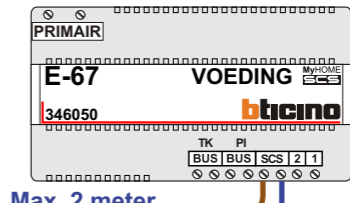
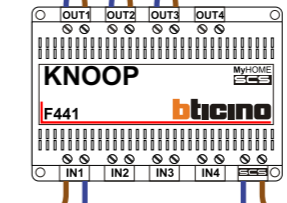

Max. 2 meter

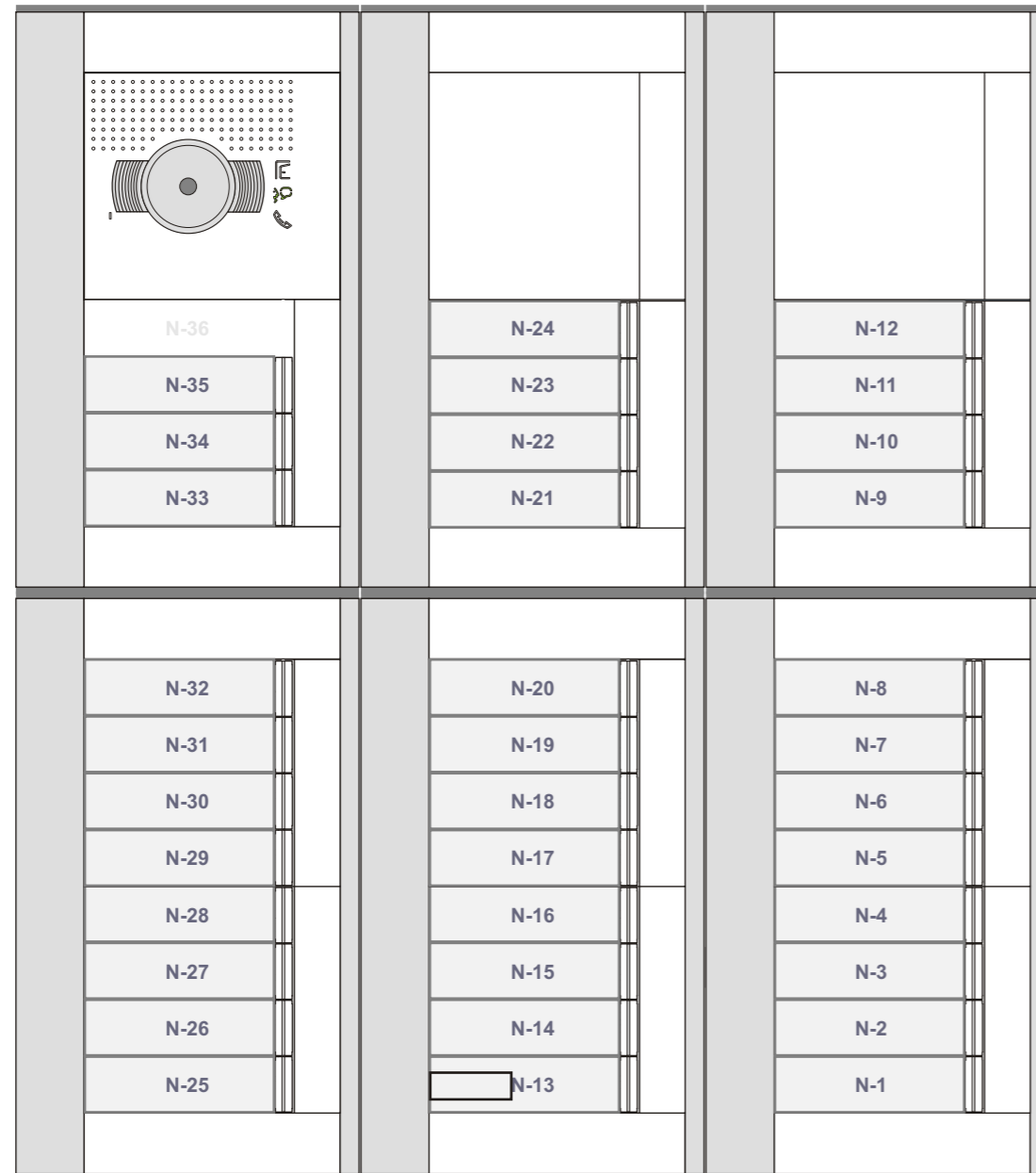

N-waarde	Huisnummer	Eindweerstand
1	43	X
2	44	X
3	45	X
4	46	X
5	47	X
6	48	X
7	49	X
8	50	X
9	51	X
10	52	X
11	53	X
12	54	X
13	67	X
14	68	X
15	69	X
16	70	X
17	71	X
18	72	X
19	73	X
20	74	X
21	75	X
22	76	X
23	77	X
24	78	X
25	90	X
26	91	X
27	92	X
28	93	X
29	94	X
30	95	X
31	96	X
32	97	X
33	98	X
34	99	X
35	100	X

INTERCOM MADE EASY