

**— = systeemkabel**  
Bij andere getwiste kabel 66% afstand!  
Bij ongetwiste kabel max. 50 meter buitenpost naar videofoon.  
UTP op aanvraag.

**TWEEDRAADS BUS**



Bij monteren/demonteren spanning eraf voorkomt defecten!

M-50

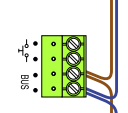

De aders moeten echt OP de connector doorgelust worden!

Haal de spanning van het systeem als je een digitizer monteert of demonteert

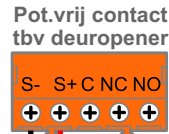
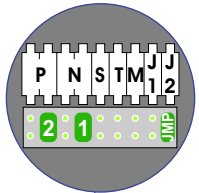

DEURSTATION S-130V

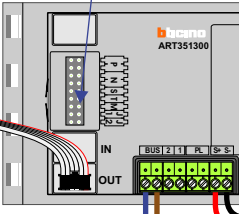

Digitizer voor 1 t/m 8 drukkers

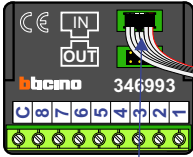

nokjes connectoren wijzen naar elkaar

Max. 50 meter

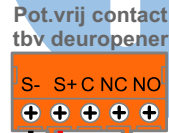
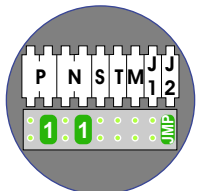

DEURSTATION S-130V

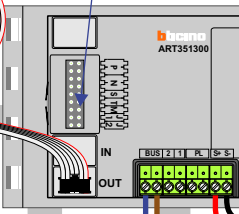

Digitizer voor 1 t/m 8 drukkers

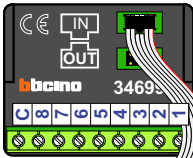

nokjes connectoren wijzen naar elkaar

Max. 50 meter

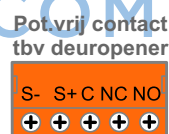
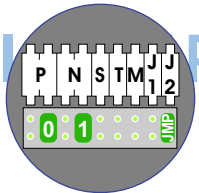

DEURSTATION S-130V

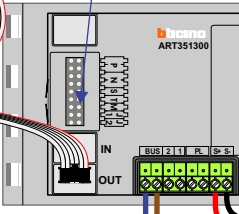

Digitizer voor 1 t/m 8 drukkers

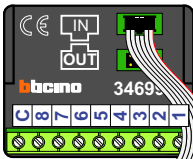

nokjes connectoren wijzen naar elkaar

Max. 50 meter

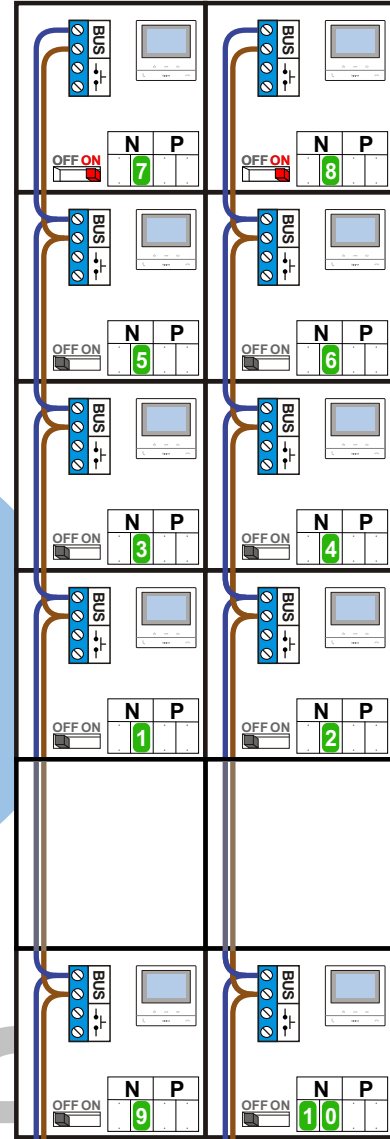

Max. 100 meter systeemkabel tot laatste videofoon

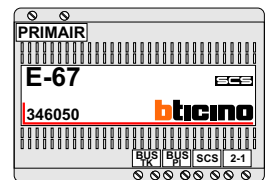
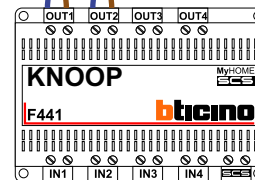

N-waarde	Huisnummer	Eindweerstand
1	11	
2	13	
3	15	
4	17	
5	19	
6	21	
7	23	X
8	25	X
9	7	
10	27	

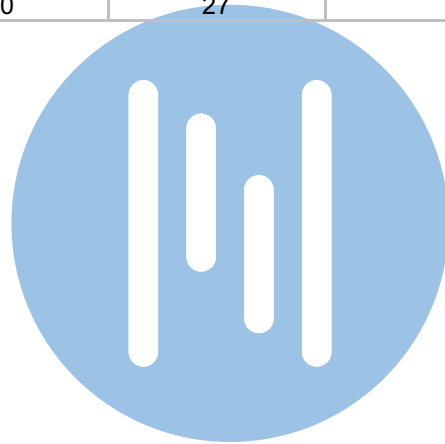

**nelec**  
INTERCOM MADE EASY

**— = systeemkabel**  
Bij andere getwiste kabel 66% afstand!  
Bij ongetwiste kabel max. 50 meter buitenpost naar videofoon.  
UTP op aanvraag.

**TWEEDRAADS BUS**



Bij monteren/demonteren spanning eraf voorkomt defecten!

M-50

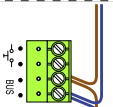

De aders moeten echt OP de connector doorgelust worden!

Haal de spanning van het systeem als je een digitizer monteert of demonteert

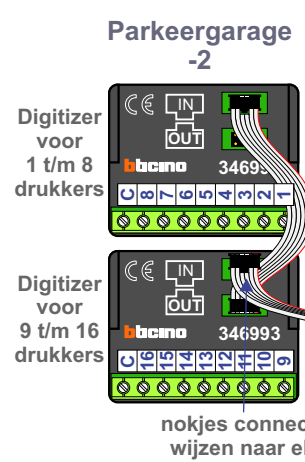
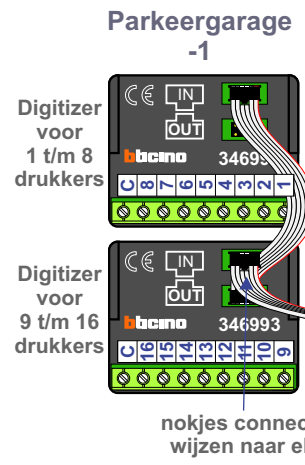
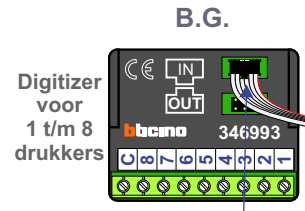
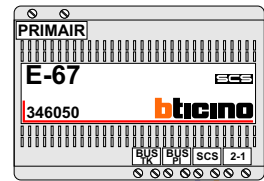
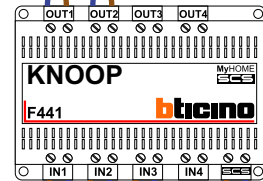
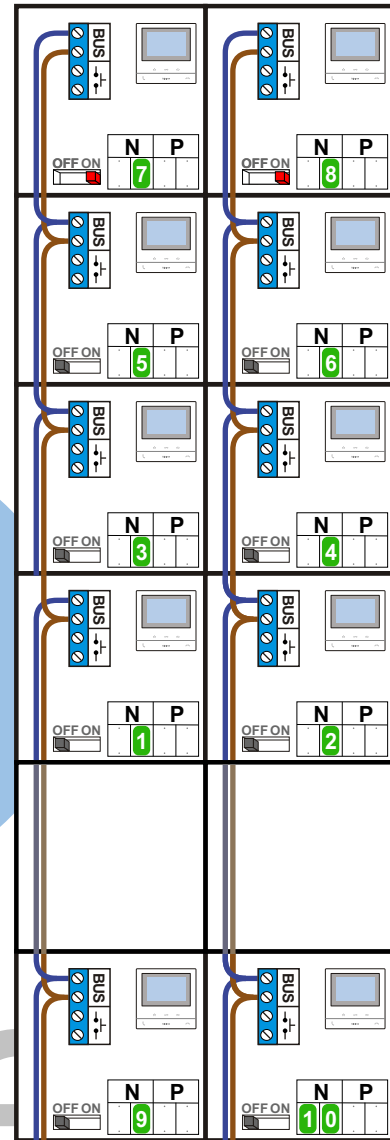
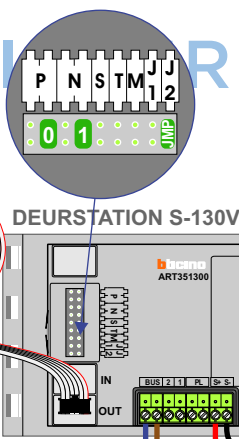
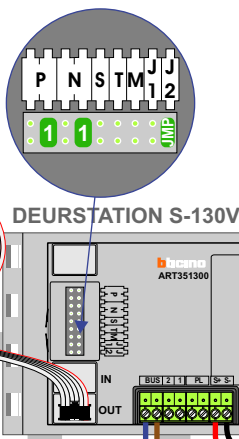
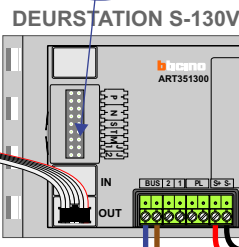
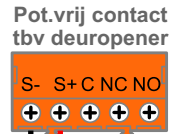
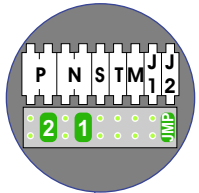

Max. 50 meter

Max. 50 meter

Max. 50 meter

Max. 100 meter systeemkabel tot laatste videofoon

N-waarde	Huisnummer	Eindweerstand
1	169	
2	171	
3	173	
4	175	
5	177	
6	179	
7	181	X
8	183	X
9	165	
10	185	

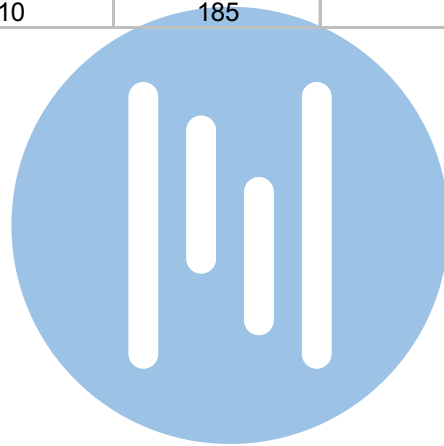

**nelec**  
INTERCOM MADE EASY

**— = systeemkabel**  
Bij andere getwiste kabel 66% afstand!  
Bij ongetwiste kabel max. 50 meter buitenpost naar videofoon.  
UTP op aanvraag.

**TWEEDRAADS BUS**



Bij monteren/demonteren spanning eraf voorkomt defecten!

M-50

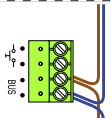

De aders moeten echt OP de connector doorgelust worden!

Haal de spanning van het systeem als je een digitizer monteert of demonteert

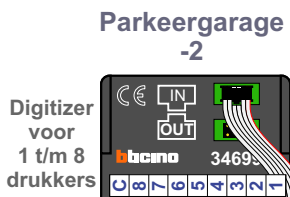
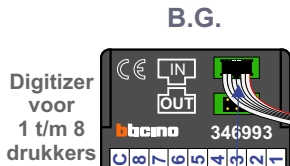
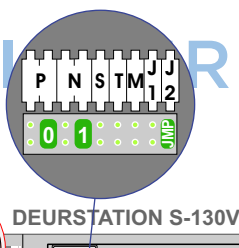
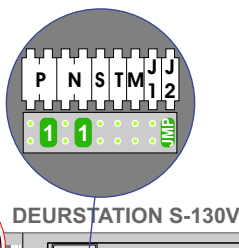
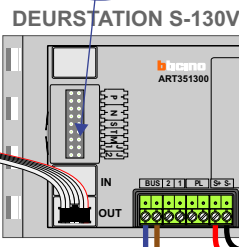
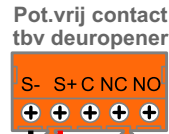
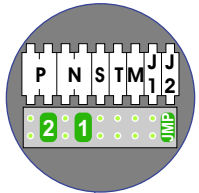

Max. 50 meter

Max. 50 meter

Max. 50 meter

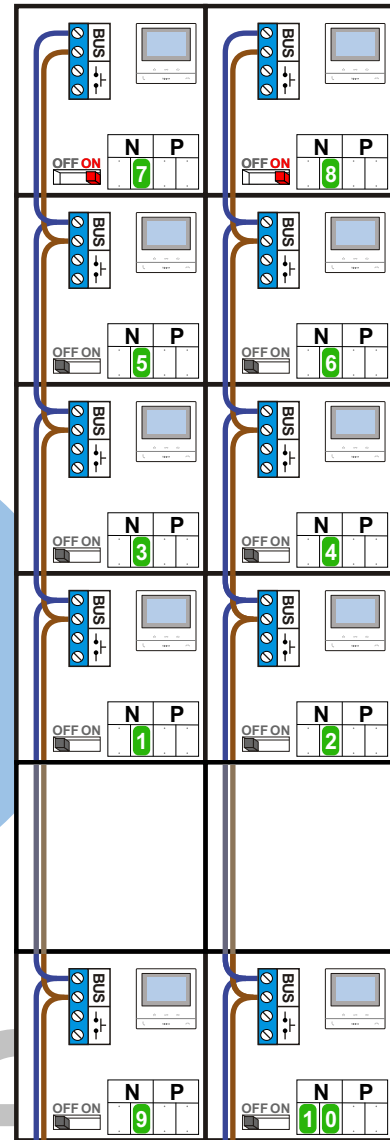

Max. 100 meter systeemkabel tot laatste videofoon

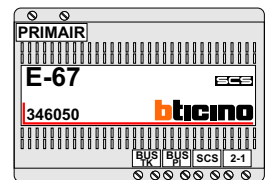
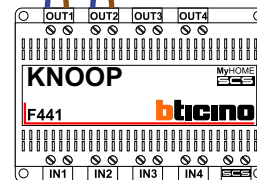

N-waarde	Huisnummer	Eindweerstand
1	335	
2	337	
3	339	
4	341	
5	343	
6	345	
7	347	X
8	349	X
9	351	
10	331	

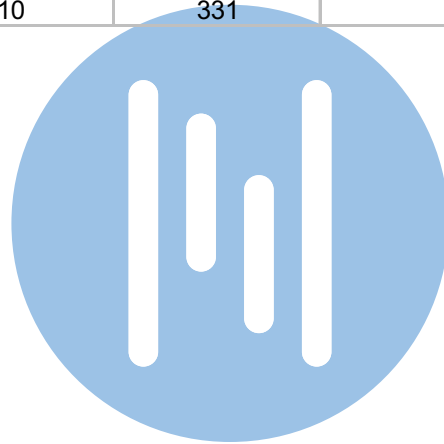

**nelec**  
INTERCOM MADE EASY