

**— = systeemkabel**  
Bij andere getwiste kabel 66% afstand!  
Bij ongetwiste kabel max. 50 meter buitenpost naar videofoon.  
UTP op aanvraag.

Digitizers & flatcables  
  
Niet monteren/demonteren onder spanning  
Beldrukkers mogen wel

TWEEDRAADS BUS  
  
Bij monteren/demonteren spanning eraf voorkomt defecten!

VideoVerdeler  
  
De aders moeten echt OP de klemmen doorgelust worden!



nelec  
INTERCOM MADE EASY

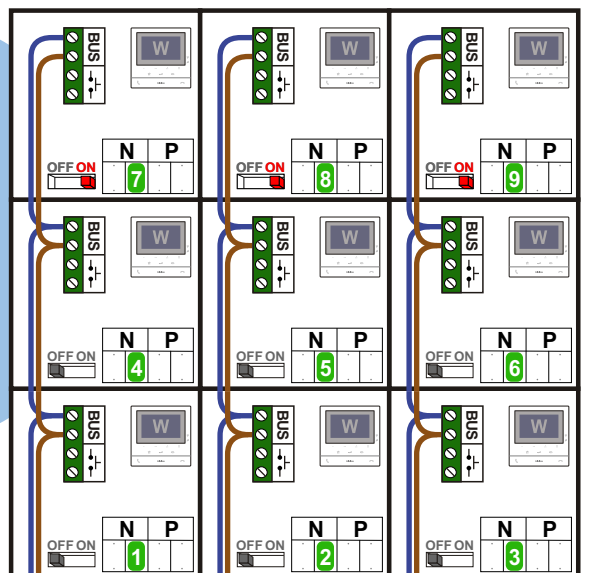

Haal de spanning van het systeem als je een digitizer monteert of demonteert

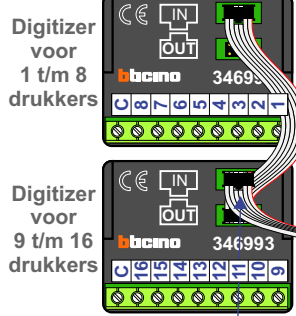
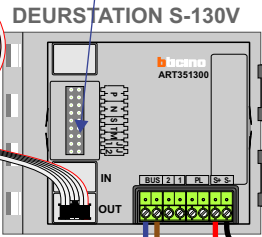
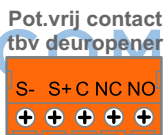
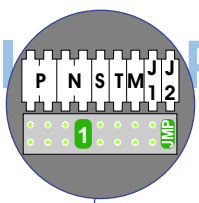

Max. 100 meter systeemkabel tot laatste videofoon

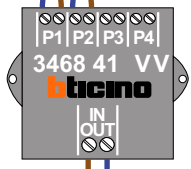
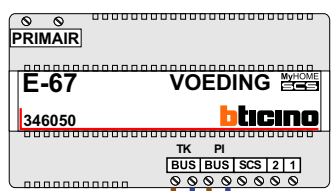

nokjes connectoren wijzen naar elkaar

Max. 50 meter

**— = systeemkabel**  
 Bij andere getwiste kabel 66% afstand!  
 Bij ongetwiste kabel max. 50 meter buitenpost naar videofoon.  
 UTP op aanvraag.

**Digitizers & flatcables**



**Niet monteren/demonteren onder spanning**  
 Beldrukkers mogen wel

**TWEEDRAADS BUS**





**Bij monteren/demonteren spanning eraf voorkomt defecten!**

**VideoVerdeler**

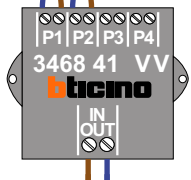
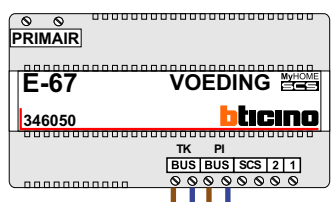
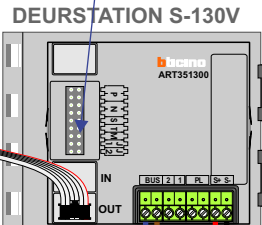
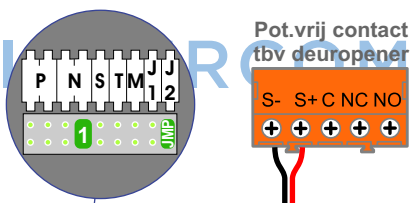
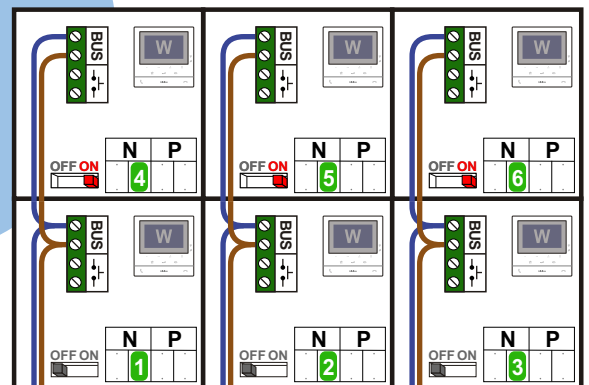
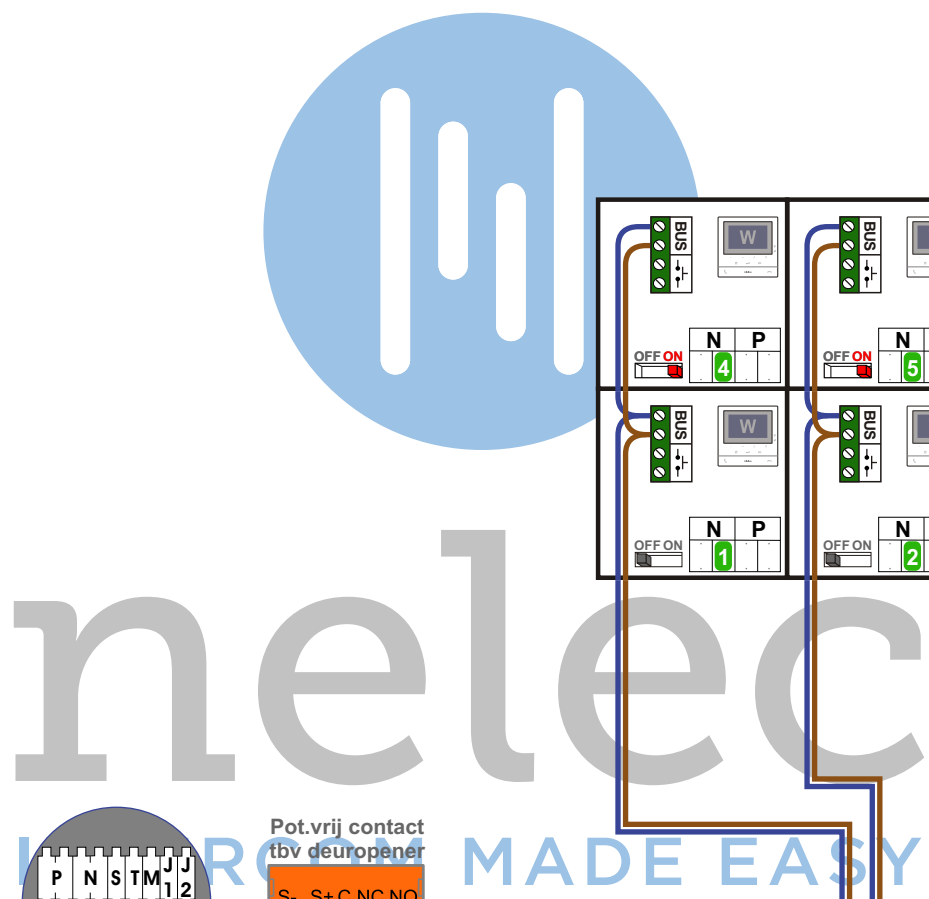

**De aders moeten echt OP de klemmen doorgelust worden!**



Max. 100 meter systeemkabel tot laatste videofoon

Max. 50 meter

nokjes connectoren wijzen naar elkaar

**Blok 1 - 9 woningen**  
**Huisnummer 357 t/m 373**

N-Waarde	Huisnummer	Switch-ON
1	357	
2	359	
3	361	
4	363	
5	365	
6	367	
7	369	X
8	371	X
9	373	X

**Blok 2 - 6 woningen**  
**Huisnummer 375 t/m 385**

N-Waarde	Huisnummer	Switch-ON
1	375	
2	377	
3	379	
4	381	X
5	383	X
6	385	X

**Blok 3 - 9 woningen**  
**Huisnummer 387 t/m 403**

N-Waarde	Huisnummer	Switch-ON
1	387	
2	389	
3	391	
4	393	
5	395	
6	397	
7	399	X
8	401	X
9	403	X

**nelec**

**INTERCOM MADE EASY**