

**— = systeemkabel**  
Bij andere getwiste kabel 66% afstand!  
Bij ongetwiste kabel max. 50 meter buitenpost naar videofoon.  
UTP op aanvraag.

**TWEEDRAADS BUS**  
   
Bij monteren/demonteren spanning eraf voorkomt defecten!

**M-50**  
  
De aders moeten echt OP de connector doorgelust worden!

**VideoVerdeler**  
  
De aders moeten echt OP de klemmen doorgelust worden!

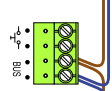
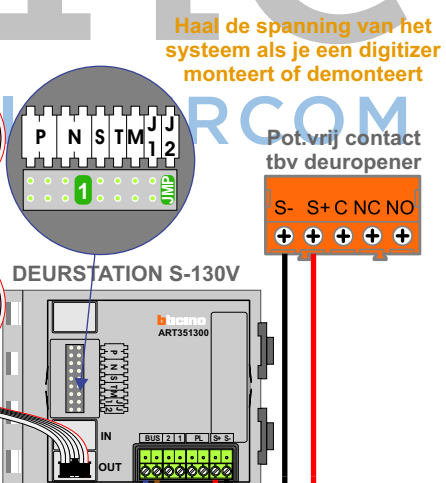
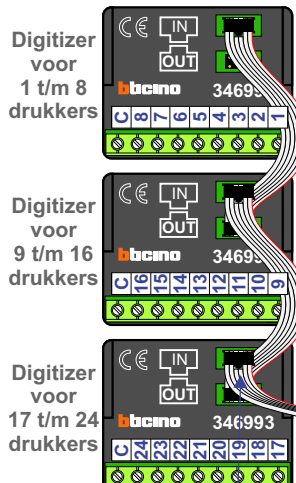
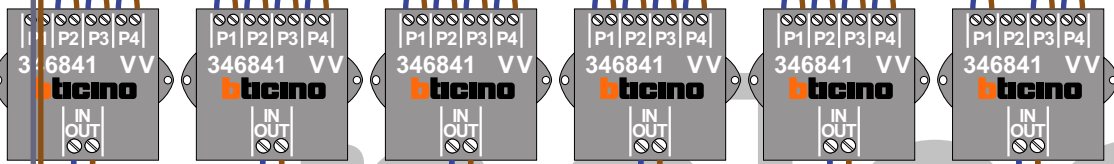
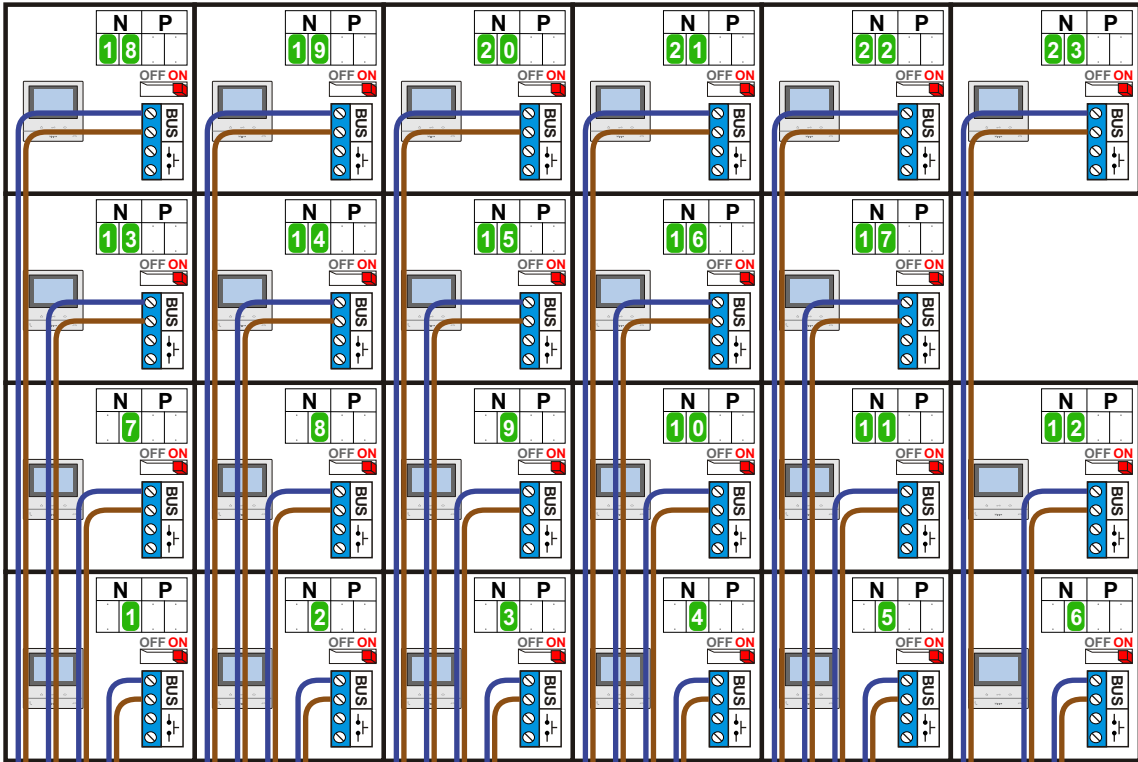

Haal de spanning van het systeem als je een digitizer monteert of demonteert

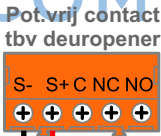

Max. 100 meter systeemkabel tot laatste videofoon

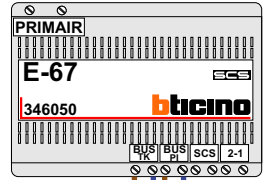

nokjes connectoren wijzen naar elkaar

Max. 50 meter

<b>N-waarde</b>	<b>Huisnummer</b>	<b>Eindweerstand</b>
1	45	X
2	47	X
3	49	X
4	51	X
5	53	X
6	55	X
7	57	X
8	59	X
9	61	X
10	63	X
11	65	X
12	67	X
13	69	X
14	71	X
15	73	X
16	75	X
17	77	X
18	81	X
19	83	X
20	85	X
21	87	X
22	89	X
23	91	X



**nelec**  
INTERCOM MADE EASY