



— = systeemkabel
 Bij andere getwiste kabel 66% afstand!
 Bij ongetwiste kabel max. 50 meter buitenpost naar videofoon.
 UTP op aanvraag.

DD8 digitizer: flatcable



Connector van flatcable nokje juiste kant op bij aansluiten op DD8

Digitizers & flatcables



Niet monteren/demonteren onder spanning
 Beldruckers mogen wel

TWEEDRAADS BUS



Bij monteren/demonteren spanning eraf voorkomt defecten!

M-50



De aders moeten echt OP de connector doorgelust worden!

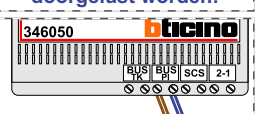

De twee stijgers echt OP de klemmen van E-67 aansluiten!



nelec
INTERCOM MADE EASY

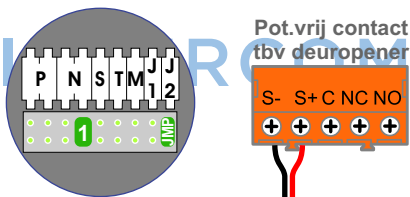
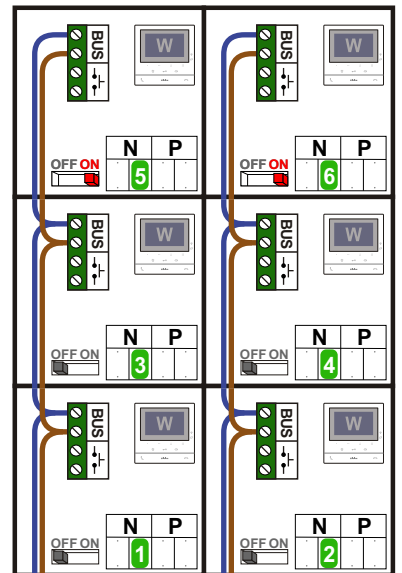

Pot.vrij contact tbv deuropener

Haal de spanning van het systeem als je de digitizer monteert of demonteert

DEURSTATION S-130V

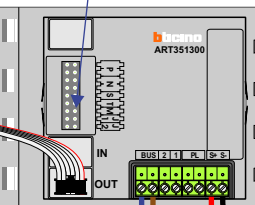

Digitizer voor 1 t/m 8 drukkers



nokjes connectoren wijzen naar elkaar

Max. 100 meter systeemkabel tot laatste videofoon

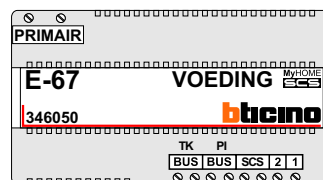

Max. 50 meter

N-Waarde	Huisnummer	Switch-ON
1	31-101	
2	31-102	
3	31-201	
4	31-202	
5	31-301	X
6	31-302	X



nelec
INTERCOM MADE EASY