

**— = systeemkabel**  
Bij andere getwiste kabel **66%** afstand!  
Bij ongetwiste kabel **max. 50 meter** buitenpost naar videofoon.  
UTP op aanvraag.

DD8 digitizer: flatcable



Digitizers & flatcables



TWEEDRAADS BUS



Bij monteren/demonteren **spanning eraf** voorkomt defecten!

VideoVerdeler

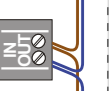

De aders moeten **echt OP de klemmen** doorgelust worden!

M-50

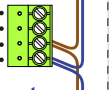

De aders moeten **echt OP de connector** doorgelust worden!

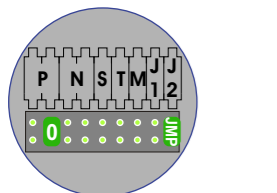
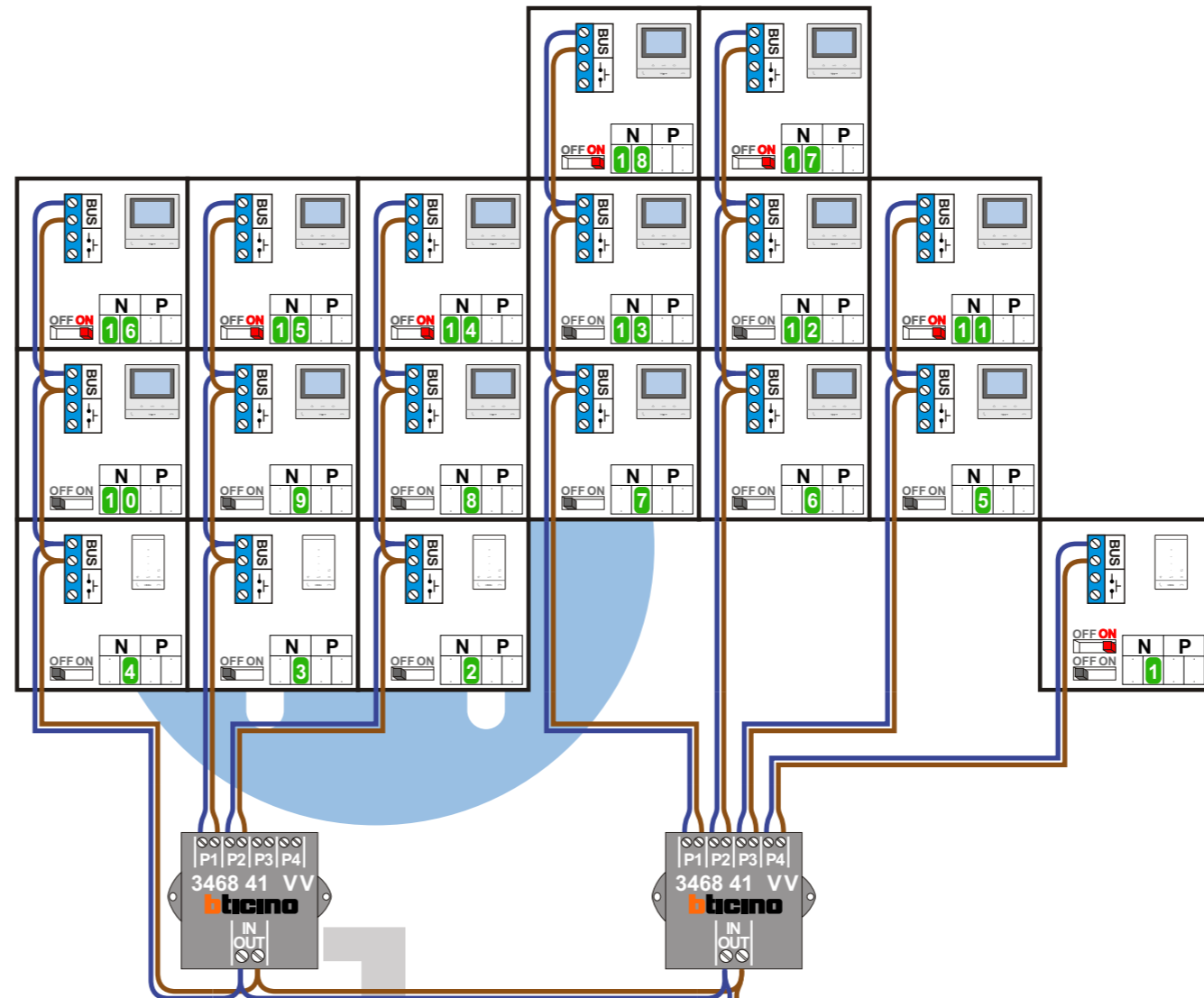

BUITENPOST S-140A

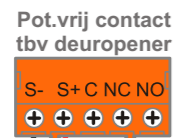
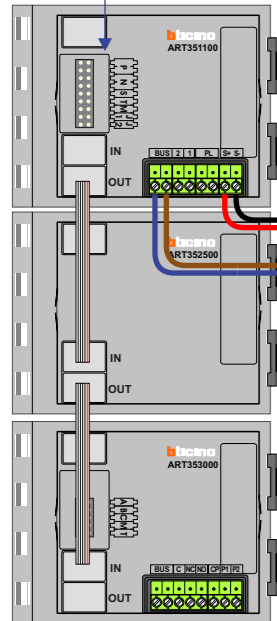

Haal de spanning van het systeem als je een digitizer monteert of demonteert

Digitizer voor 1 t/m 8 drukkers

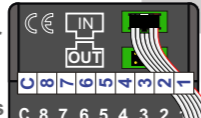

Digitizer voor 9 t/m 16 drukkers

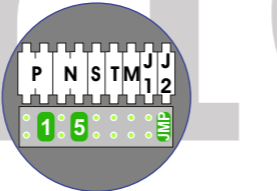
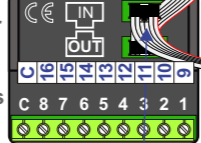

BUITENPOST S-130V

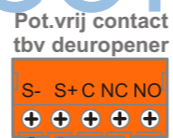
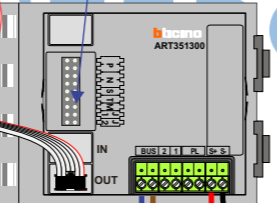

nokjes connectoren wijzen naar elkaar

Max. 50 meter

Max. 290 meter

Max. 100 meter systeemkabel tot laatste videofoon

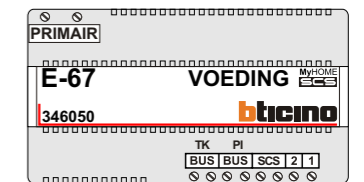

N-waarde	Huisnummer	E indweers tand	Toes tel
1	57	X	T-55
2	1A15		T-55
3	1A16		T-55
4	1A17		T-55
5	1B1		M-50b
6	1B2		M-50b
7	1B3		M-50b
8	1B4		M-50b
9	1B5		M-50b
10	1B6		M-50b
11	1C7	X	M-50b
12	1C8		M-50b
13	1C9		M-50b
14	1C10	X	M-50b
15	1C11	X	M-50b
16	1C12	X	M-50b
17	1D13	X	M-50b
18	1D14	X	M-50b

nelec  
INTERCOM MADE EASY